

# 99 TOP Series

## Multi-voltage electric lock



HI-TECH

Latest generation characterized by its versatility.

The TOP variant of this series introduces a new system for guiding the latch into the latch lock for easy door opening and avoids the need for a frame notch.

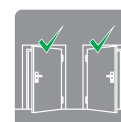
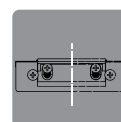
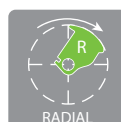
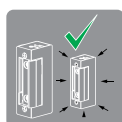
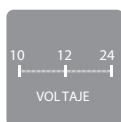

- New system with latch ramp guide
- Cover with galling system
- Multivoltage
- AC and DC operation
- Reduced size
- Radial latch
- Symmetrical
- Reversible
- EN 14846 certification



Model **99** with installation with cut in frame



Model **99 TOP** with installation without cut in frame

# Casing

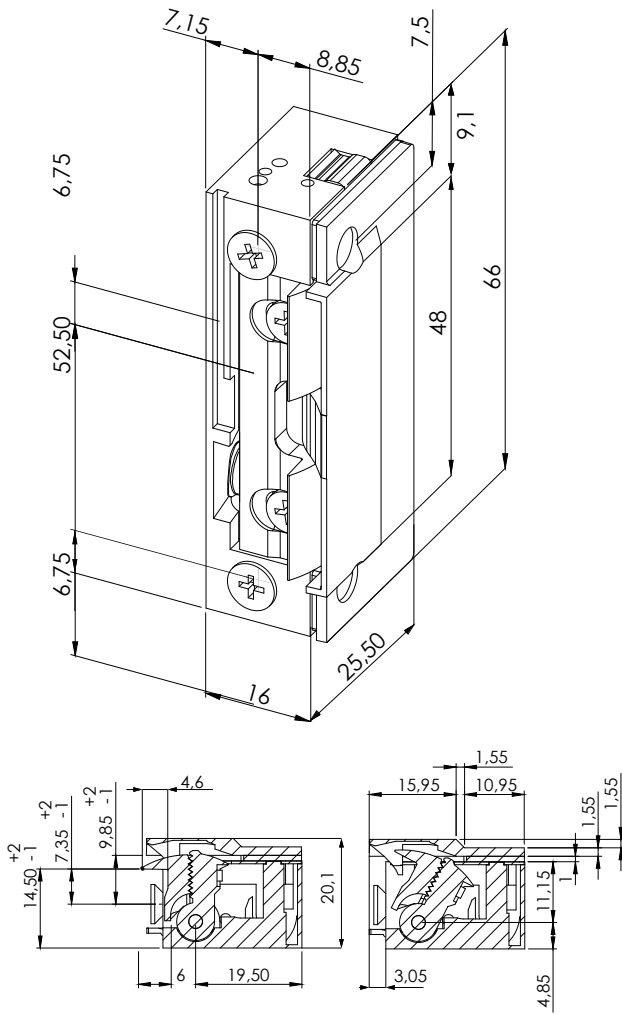

Stainless steel

# Technical Features

Height	66 mm
Width	16 mm
Depth	25,5 mm
Adjustable Jaw Range	+2-1 mm
Suits Latches With Maximum Throw Of	5,1 mm
Endurance Cycles Test In-plant	400.000
Holding Force	3.230 N / 330 kg-f
Operating Temperature Range	-15 °C to +40 °C
Diode Or Varistor	Optional
Microswitch	Optional

# Recommended striking plate

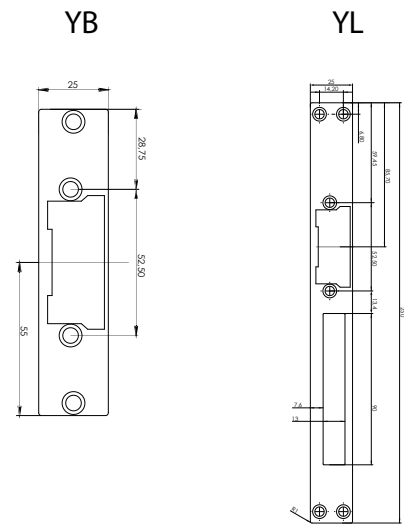

	NORMAL	STANDARD AUTOMATIC	INVISIBLE AUTOMATIC	TIMED AUTOMATIC	SLIDING AUTOMATIC	INVERTED	SWITCHED	UNBLOCKING	ADJUSTABLE *	WORKING VOLTAGE
9902T	✓							✓	✓	10-24V AC/DC
9904T		✓						✓	✓	10-24V AC/DC
9913T					✓				✓	12V DC
9932T	✓						✓		✓	10-24V AC/DC
9934T					✓	✓			✓	12V DC

\* By regulating screws in latch

ZKTeco Europe.

Av. Camino de lo Cortao, 10. Nave 1.  
28703 San Sebastián de los Reyes. Madrid. SPAIN  
Tel: +34 916 532 891 E-mail: sales@zkteco.eu  
www.zkteco.eu

© Copyright 2015. ZKTeco Inc. ZKTeco Logo is a registered trademark of ZKTeco or a related company. All other product and company names mentioned are used for identification purposes only and may be the trademarks of their respective owners. All specifications are subject to change without notice. All rights reserved.

