

Quick Start Guide

UHF 6Pro Series Reader

Version: 1.0

Date: August 2018

1. Product Summary

UHF 6Pro series is a new generation of RFID UHF series product of our company's independent research and development of the long distance card reader system for parking lots.

The product adapts Impinj R2000 card reader chip, and the card reader part adapts module integrated design. It has stable card reading performance, good card reading performance consistency, long service span, minimized external interference, and the product adapts waterproof casing design.

The product also fully meets the CE, FCC technology requirements of the product, and has obtained CE, FCC and other security certifications.

2. Overview

Front View

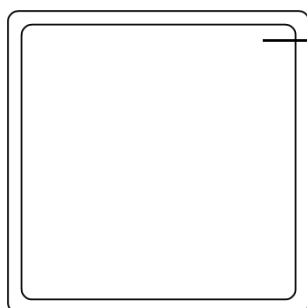

Antenna

Working Frequency:

UHF 6E Pro: 865MHz ~ 868MHz

UHF 6F Pro: 902MHz ~ 928MHz

Read Range:

Handheld stable 18 meters

Lateral View and Interface

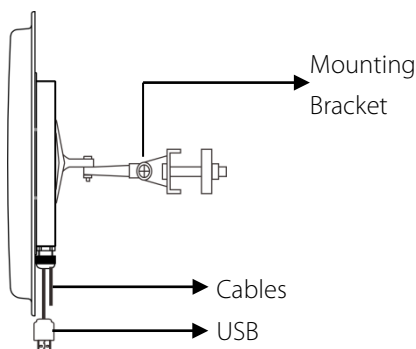

Cable Definition

NO	Color	Function
1	Red	+12V
2	Black	GND
3	Purple	Trigger Point (Active-low)
4	Green	Wiegand D0
5	White	Wiegand D1
6	USB Connector	

NOTE:

- 1) In "Trigger Read" work mode, the reader will not read cards before a low level signal to "Trigger Point" is delivered. "Trigger Point" is mainly used for working with the ground sensor of vehicle parking system.
- 2) In "Always Read" work mode, once the card is in the effective range, the reader will output the card number via Wiegand continually.

3. Technical Parameter

Working Voltage	DC9V ~ 12V
Working Current	1.2A +/-10%
Working Temperature	-20 °C ~ +60 °C
Working Humidity	<95%(+25°C)
Interface Protocol	EPC global UHF Class 1Gen2/ ISO 18000-6C,ISO 18000-6B
Working Frequency	865MHz~868MHz;902MHz~928MHz
Output Power	10dBm ~ 33dBm
Communication Interface	Wiegand 26/34; USB
Reading Distance	Stable 18 meters
Antenna Gain	9dBi
Dimension	310mm*310mm*90mm(±5mm)
Length of cable	1400±50mm

4. Safety Precautions

- 1) The reader working voltage ranges from DC9V to DC16V, it is recommended to use DC12V /3A power supply.
- 2) Please wire according to the cable definition.

5. Modifying Setting via Demo

1) USB Connection

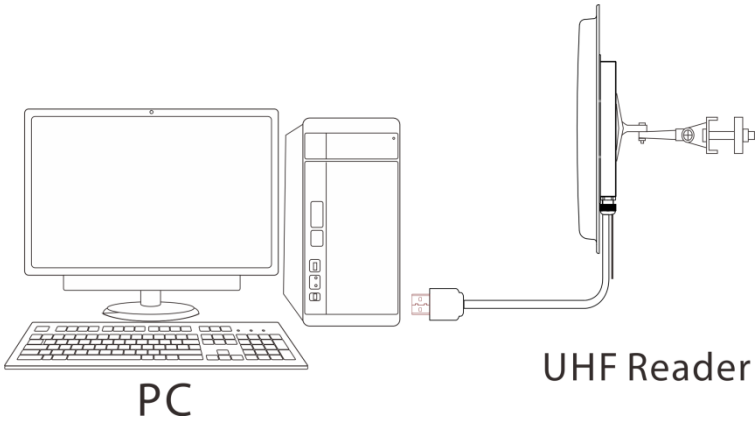

2) Software Introduction

Our company provides Demo, used to set the working parameters of the reader. Demo interface is as shown below:

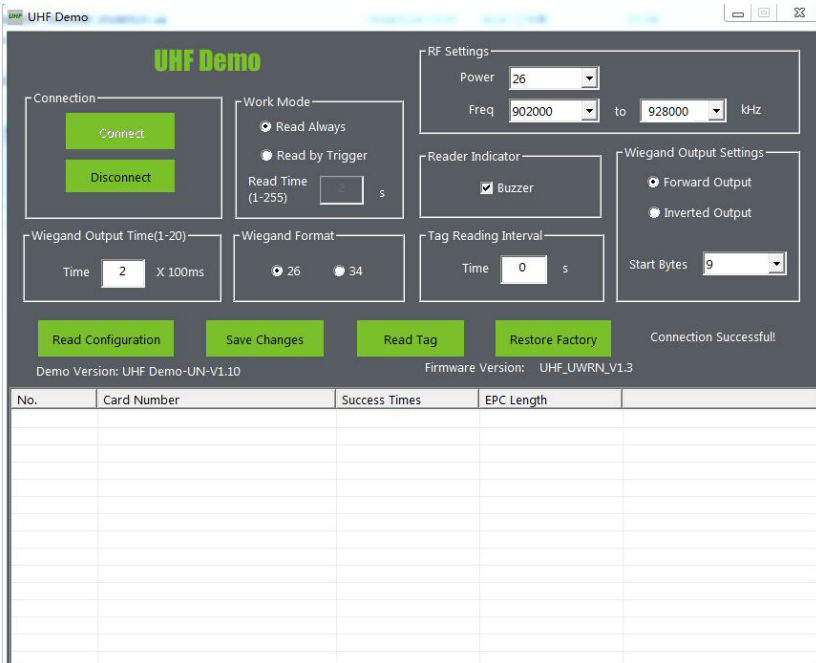

The default configuration of the reader is as follows:

Work Mode	Read Always
Communication Interface	Wiegand26
Output Power	33dBm
Working Frequency	UHF 6E Pro: 865MHz ~ 868MHz; UHF 6F Pro: 902MHz ~928MHz

Demo Using Instructions

- Connect the USB port of the reader to the USB port of the computer.
- It is recommended to use power adapter with DC12V/3A specifications.
- To play Demo in computer, click “Connect”, on the right side of the middle will show “Successfully Connected”.
- **Wiegand Output Time:** Sets the time interval between adjacent wiegand data.
- **Reader Indicate:** Set whether the buzzer rings when the machine is on the electricity and brush the card.
- **Work Mode:** Set the working mode of the machine, and including always read mode, trigger mode. Under trigger mode, time of reading card can be set when it is triggered once.
- **RF Setting:** Set the RF parameters of the machine, including power, spectrum. Power range is 10~33dBm.
- **Wiegand Format:** Set the machine's wiegand output format.
- **Wiegand Output Settings:** Sets the forward or reverse output of the machine's Wiegand Data, and start output from the first few bytes.
- **Tag Reading Interval:** Set the machine to read the card interval. Read card interval is the time when from the card is read within the scope of the card to the card is left out of the scope of the card to read the second time card.

6. Access Control Panels Connection

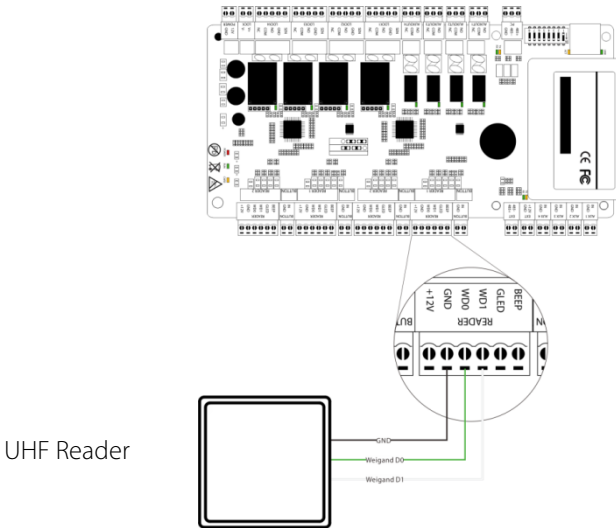

7. Installation

- Please install the directional antenna with lower elevation angle of 60~75 to suit the correct line of sight.

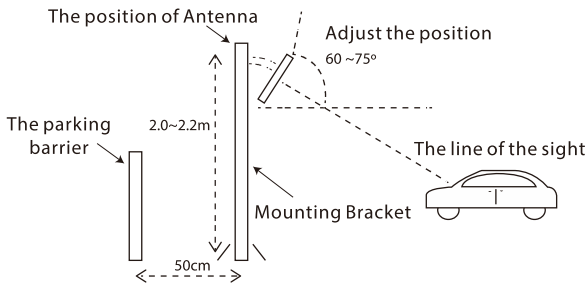

NOTE:

- Please install the reader as shown in the above picture. The reader is facing the direction and the direction of travel of the vehicle is in a straight line.
- The distance between the reading head and the parking barrier is maintained at 50cm or more.

- Avoid installing the reader against to another.

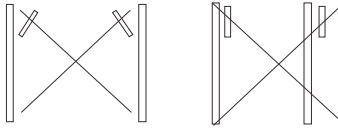

- The position of the tag/card in the vehicle is as follows:

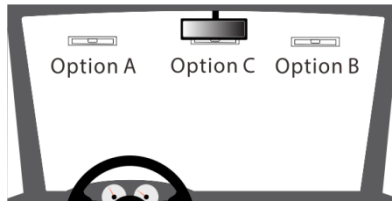

- The reader detection distance may vary depending on rain, snow or wind.



- The Reader should be away from strong magnetic field when working.

ZK Building, Wuhe Road, Gangtou, Bantian, Buji Town,
Longgang District, Shenzhen China 518129

Tel: +86 755-89602345

Fax: +86 755-89602394

www.zkteco.com

