

# ZK-ML280K

## Rim Mounting Electromagnetic Lock

The electromagnetic locks are used to close heavy duty or emergency exit doors. They are connected to an access control and they are energized by a stabilized power supply in 12/24 VDC with battery backup and release the doors when the power is off. They are provided by a Led and a Relay to inform the door is open or closed to the access control.

With a built-in monitoring system (Door open or closed signal) and varistor included. Rim installation accessory kit on request. 12 or 24V functioning. ZK-ML280K supports a holding force of 280 kg.



- Silent
- LED information (Open/Closed)
- Rim Mounting
- Without mechanical wear

	ZK-ML180K	ZK-ML280K	ZK-ML350K	ZK-ML500K
Height	170 mm	250 mm	250 mm	265 mm
Width	40 mm	54 mm	64 mm	73 mm
Depth	21 mm	27 mm	32 mm	40 mm
Holding force	180 Kg / 300 lb	280 Kg / 600 lb	350 Kg / 800 lb	500 Kg / 1200 lb
Signaling	LED	LED	LED	LED
Monitoring contact	NO	YES	YES	YES
Functioning	12 VDC	12 VDC / 24 VDC	12 VDC / 24 VDC	12 VDC / 24 VDC
DC Current consumption	360 mA	400 mA (12 VDC) 200 mA (24 VDC)	400 mA (12 VDC) 200 mA (24 VDC)	400 mA (12 VDC) 200 mA (24 VDC)

## Dimensions

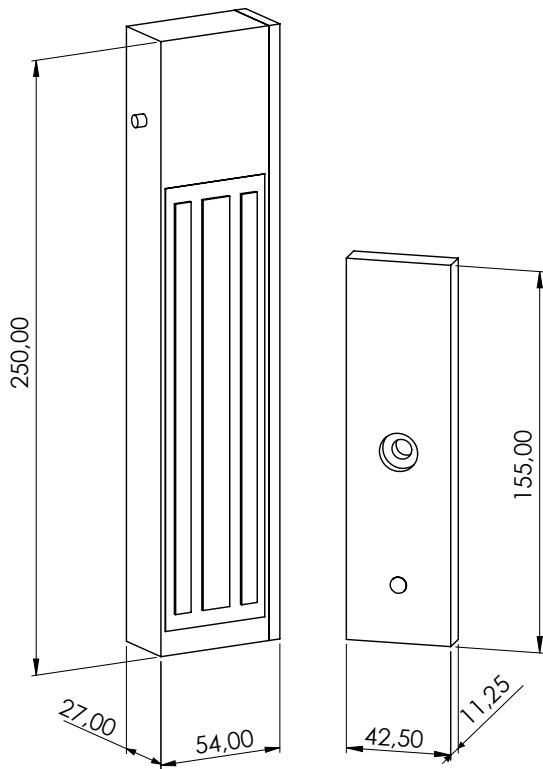

## Typical Rim Installation

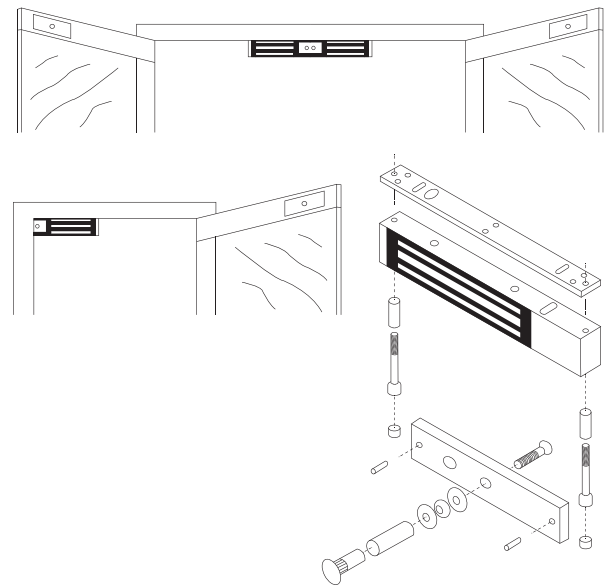

## Compatible brackets



ZK-ML280K-L



ZK-ML280K-Z



ZK-ML280K-U